

KRHAM

COMPONENTS FOR TOP HAMMER

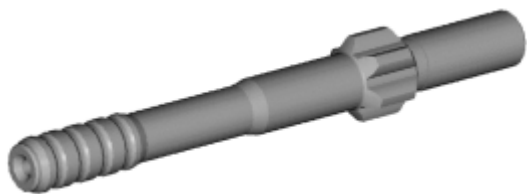

Shank Adapters

2-20

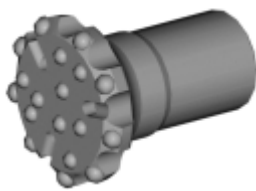

Button Bits

21-25

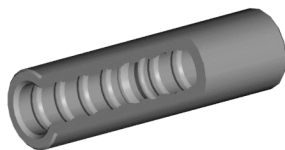

Coupling Sleeve

26

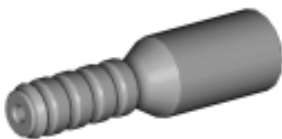

Bit adapter Coupling

27

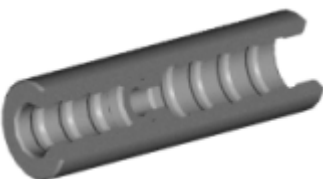

Reduction Coupling

28

Shank adapters

R25 (1")

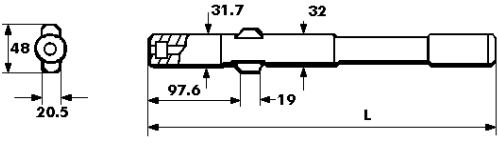
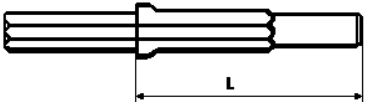
Adapter 25mm (1")	Long. mm	Drifter	Ordering Number	Flushing Tube	Weight
	381	BBC 44,100 Gardner-Denver 93 Ingersoll 350 Joy 400 RR Montabert TA 35, LC 50	152501	10	2.0
	255	Barra Culata	152502	8	1.6

Shank adapters

R28 (1" 1/8)

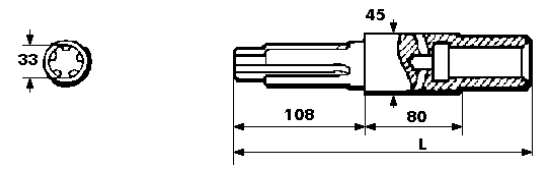
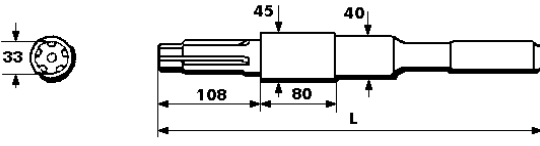
Adapter 28mm (1" 1/8)	Long. mm	Drifter	Ordering Number	Flushing Tube	Weight
	244	Cop 1028	152801	-	1.7
	400	Cop 1028	152802	-	2.5

Shank adapters

R32 (1" 1/4)

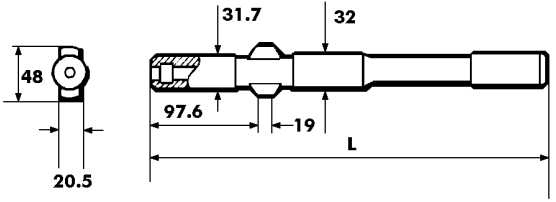
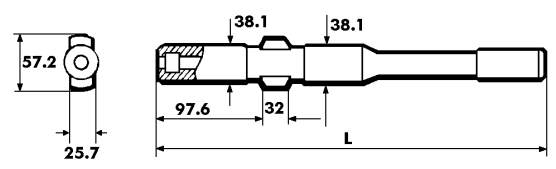
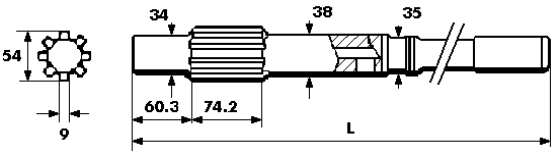
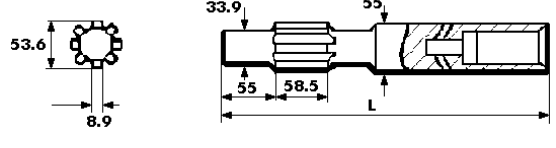
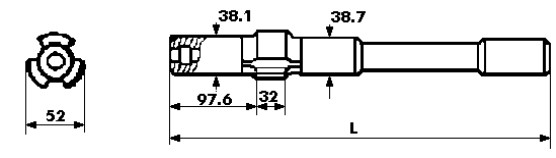
Adapter 32mm (1" 1/4)	Long. mm	Drifter	Ordering Number	Flushing Tube	Weight
	381	BBC 44, 100 Gardner-Denver 93 Ingersoll 350 Joy 400 RR Montabert TA 35, LC 50	153201	10	2.0
	380	BBC 51, 52, 54, 120 Böhler HM 751, HM 755 Montabert H40, H50, H60	153202	10	2.6
	574	Cop 1038 HL	153203	-	4.4
	339	Cop 1032 HD	153204	-	4.5
	380	Cop 125, 130, 131	153205	14.3	2.7

Shank adapters

R32 (1"1/4)

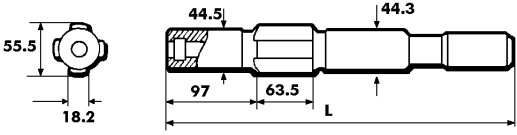
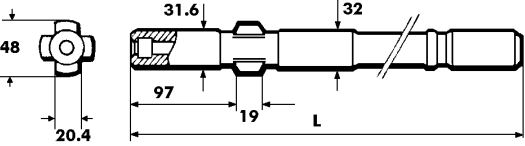
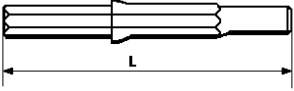
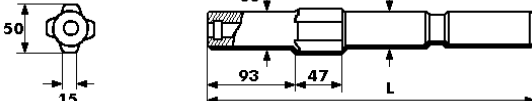
Adapter 32mm (1"1/4)	Long. mm	Drifter	Ordering Number	Flushing Tube	Weight
	343	Ingersoll-Rand URD 475, 550 VL 120, 140 Furukawa MD 120, HD 120 Gardner-Denver PR 123, 133 Le-Roi 155, 455R, LHD 155 Tamrock L600, L750 Toyo PR 220	153206	14.3	3.6
	380	Tamrock L400, L500	153207	10	4.3
	338	Barra Culata	153208	8	1.8
	347	YD 90	153209	10	2.1

Shank adapters

R38 (1" 1/2)

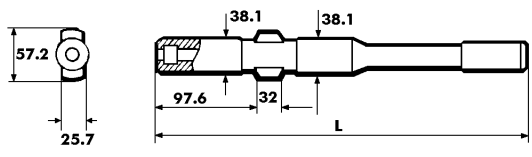
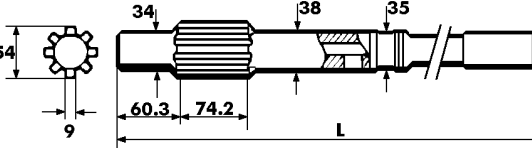
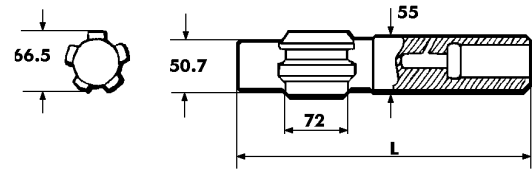
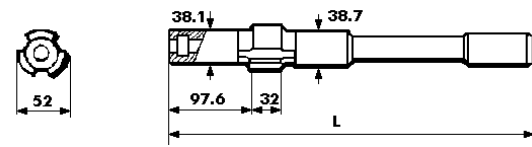
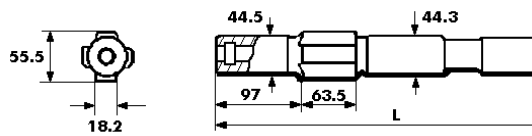
Adapter 38mm (1" 1/2)	Long. mm	Drifter	Ordering Number	Flushing Tube	Weight
	390	BBC 51, 52, 54, 120 Bölher HM 751, HM 755 Montabert H40, H50, H60	153801	10	2.6
	462	Cop 1038 HD	153802	-	5.0
	330	Cop 126	153803	-	2.2
	380	Cop 125, 130, 131	153805	14.3	2.7
	343	Ingersoll-Rand URD 475, 550 VL 120, 140 Furukawa MD 120, HD 120 Gardner-Denver PR 123, 133 Le-Roi 155, 455R, LHD 155 Tamrock L600, L750 Toyo PR 220	153806	14.3	3.6

Shank adapters

R38 (1" 1/2)

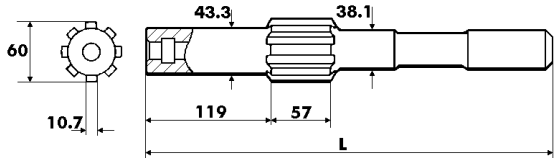
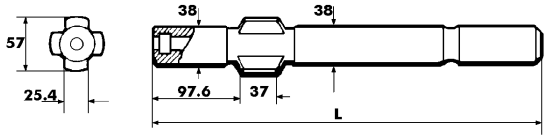
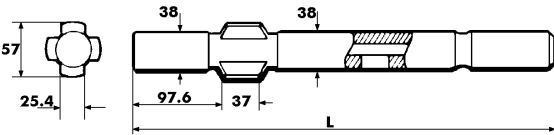
Adapter 38mm (1" 1/2)	Long. mm	Drifter	Ordering Number	Flushing Tube	Weight
	410	Joy VCR 260, 261, 360	153807	16	3.9
	390	Tamrock HL438, HL538	153808	12.7	3.0
	450	Tamrock HL438, HL538	153809	-	4.3

Shank adapters

T38 (1" 1/2)

Adapter 38mm (1" 1/2)	Long. mm	Drifter	Ordering Number	Flushing Tube	Weight
	496	Bölher HD 125, HD 150	103801	-	4.1
	501	BBC 51, 52, 54, 120 Bölher HM 751, HM 755 Montabert H40, H50, H60	103802	10	2.6
	380	Cop 125, 130, 131	103803	14.3	2.7
	557	Cop 150	103804	16	6.7
	573	Cop 1038 HL	103805	-	5.0
	407	Cop 131 EB	103806	14.3	3.4
	370	Cop 115, 932 MC	103807	10	3.0

Shank adapters

T38 (1" 1/2)

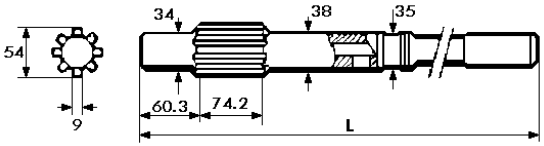
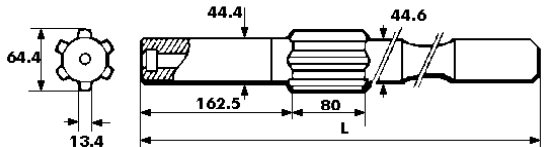
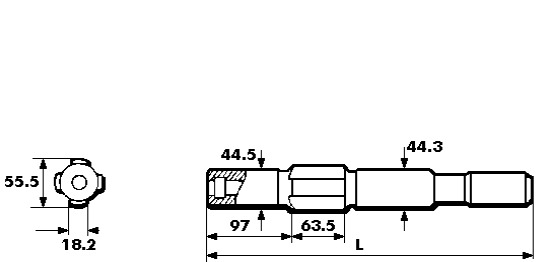
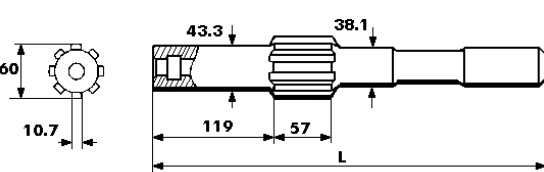
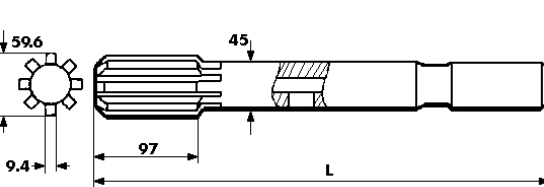
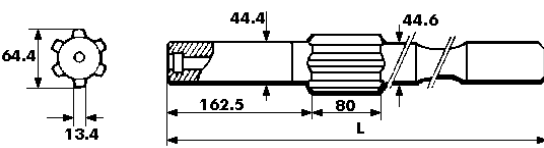
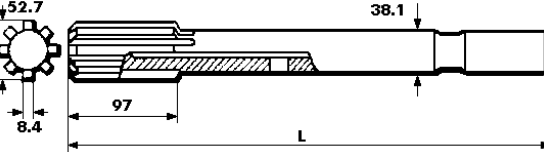
Adapter 38mm (1" 1/2)	Long. mm	Drifter	Ordering Number	Flushing Tube	Weight
	499	Cop 1038 HB, 1036 HB, 1238	103808	-	4.4
	530	BBE 56,57 Montabert H 100 Ingersoll 401	103809	14.3	5.3
	343	Ingersoll-Rand URD 475, 550 VL 120, 140 Furukawa MD 120, HD 120 Gardner-Denver PR 123, 133 Le-Roi 155, 455R, LHD 155 Tamrock L600, L750 Toyo PR 220	103810	14.3	3.6
	410	Joy VCR 260, 261, 360	103811	16	3.9
	474	Montabert HC 120	103812	-	5.6
	447	BBE 56, 57, Montabert H 100	103813	14.3	4.5
	498	Montabert HC 80	103814	-	4.9

Shank adapters

T38 (1" 1/2)

Adapter 38mm (1" 1/2)	Long. mm	Drifter	Ordering Number	Flushing Tube	Weight
	390	Tamrock HL 438, HL 538	103815	12.7	3.0
	450	Tamrock HL438, HL538	103816	-	4.3
	555 464	Tamrock HL 500	103817 103824	- -	4.0 3.2
	599	Tamrock HL 600	103818	-	6.2
	486	Ingersoll YH 65	103819	19	5.0
	508	Cop 938 MS	103821	-	4.4
	600	Tamrock HL 645	103822	-	6.5

Shank adapters

T38 (1" 1/2)

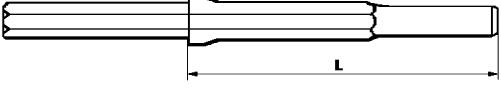
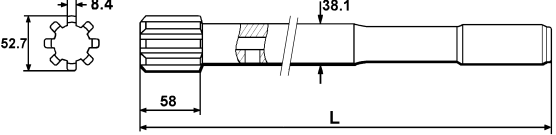
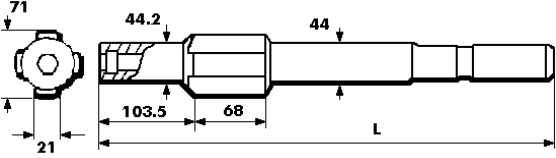
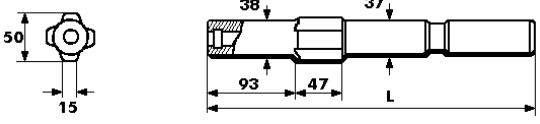
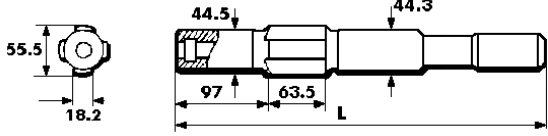
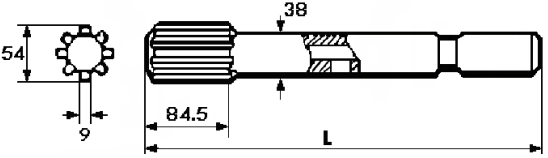
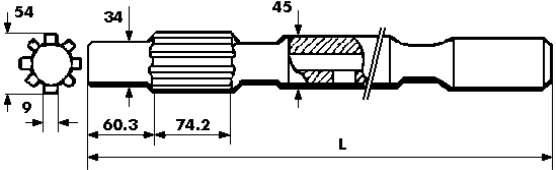
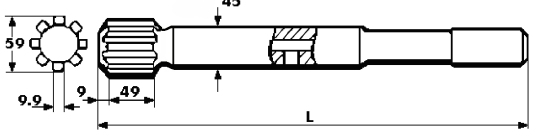
Adapter 38mm (1" 1/2)	Long. mm	Drifter	Ordering Number	Flushing Tube	Weight
	608	Barra Culata	103823	-	3.6
	447	Montabert HC 40	103825	-	3.5
	482	Furukawa PD 200	103826	14	5.3
	347	YD 90	103827	10	2.5
	393	VL-140	103828	14.3	4.2
	439	Cop 1838	103829	-	4.0
	575	Cop 1238	103830	-	5.4
	500	Tamrock HL 550 Super, M 92	103831	-	5.2

Shank adapters

T45 (1"3/4)

Adapter 45mm (1"3/4)	Long. mm	Drifter	Ordering Number	Flushing Tube	Weight
	499	Cop 1238	104502	-	4.4
	557	Cop 150	104503	16	6.7
	486	Ingersoll YH 65	104504	19	5.3
	354	Ingersoll-Rand URD 475, 550 VL 120, 140 Furukawa MD 120, HD 120 Gardner-Denver PR 123, 133 Le-Roi 155, 455R, LHD 155 Tamrock L600, L750 Toyo PR 220	104505	14.3	3.6
	530	BBE 56, 57 Montabert HL 100 Ingersoll YH 60	104506	14.3	5.3
	490	Montabert HC 120	104508	-	5.6

Shank adapters

T45 (1"3/4)

Adapter 45mm (1"3/4)	Long. mm	Drifter	Ordering Number	Flushing Tube	Weight
	499	Tamrock HL 850	104509	19	6.1
	599	Tamrock HL 600	104510	-	6.2
	600	Tamrock HL 645	104512	-	6.5
	670	Tamrock HL 850	104513	-	7.5
	555	Tamrock HL 500	104514	-	4.0
	482	Furukawa PD 200	104515	14	5.5
	670.5	Montabert HC 120 R	104517	-	7.5

Shank adapters

T45 (1"3/4)

Adapter 45mm (1"3/4)	Long. mm	Drifter	Ordering Number	Flushing Tube	Weight
	590	Cop 1238	104518	-	5.2
	655	Furukawa HD 300	104519	16	6.7
	670.5	Montabert HC 80 R	104520	-	7.3
	525	Cop 1550,1838	104521	-	6.2
	587.9	Tamrock HL 700	104523	-	8.0
	638	Soosan Mitsui	104524	16	9.0
	495	Ingersoll YH 80 A, YH 65, YH 70	104525	20	7.0

Shank adapters

T45 (1"3/4)

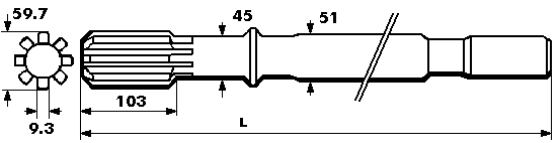
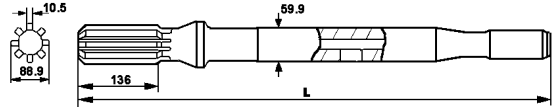
Adapter 45mm (1"3/4)	Long. mm	Drifter	Ordering Number	Flushing Tube	Weight
	771.5	Montabert HC 120 RL	104526	-	9.2
	807	Montabert HC 160 R	104527	-	10.3

Shank adapters

T5I (2")

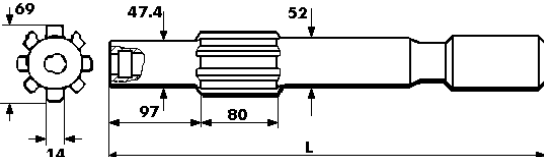
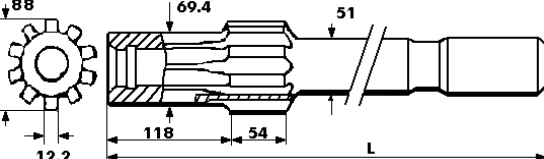
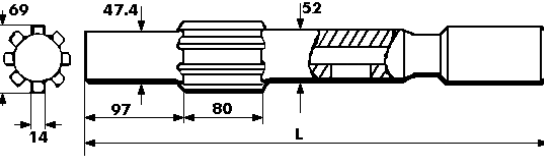
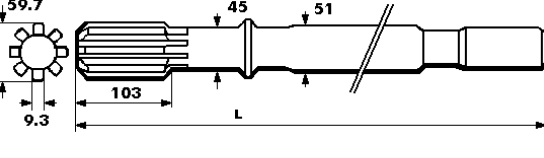
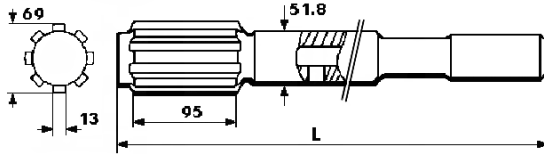
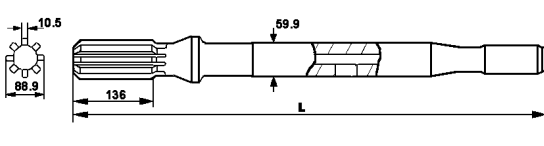
Adapter 51mm (2")	Long. mm	Drifter	Ordering Number	Flushing Tube	Weight
	499	Tamrock HL 850	105101	19	7.0
	507	Joy VCR 280	105102	32	8.1
	670	Tamrock HL 850	105103	-	7.5
	670.5	Montabert HC 120 R	105104	-	8.8
	587.9	Tamrock HL 700	105106	-	8.2
	807	Montabert HC 160 R	105107	-	10.4

Shank adapters

H55

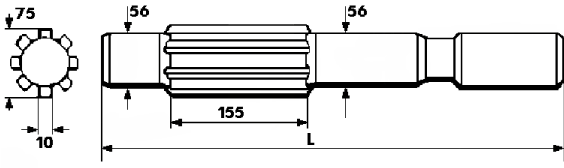
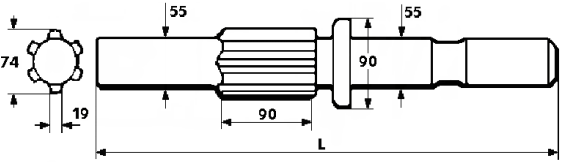
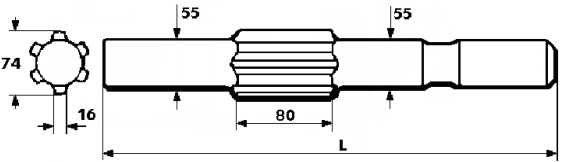
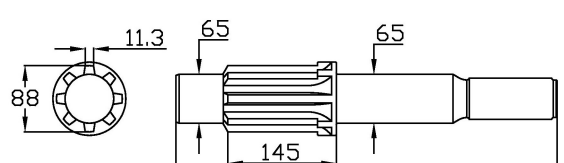
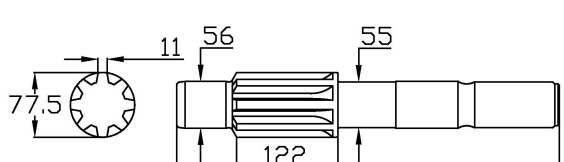
Adapter 55mm	Long. mm	Drifter	Ordering Number	Flushing Tube	Weight
	500	Klemm 4026/4053	155501	-	10.5
	581	Krupp HB 30A, 40A	155502	-	12.0
	501	Krupp HB 103	155503	-	9.4
	510	Eurodrill HD 4008	155507	-	10
	461	Eurodrill HD 2004	155508	-	9

Shank adapters

H64

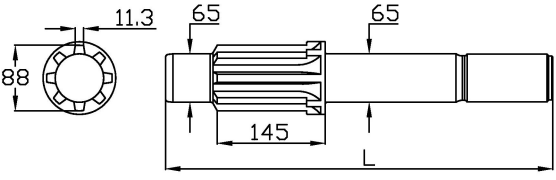
Adapter 64mm	Long. mm	Drifter	Ordering Number	Flushing Tube	Weight
	520	Eurodrill HD 4008	156404	-	15

Shank adapters

H90

Adapter 90mm	Long. mm	Drifter	Ordering Number	Flushing Tube	Weight
	752	Krupp HB-50	1509002	-	35
	575	Eurodrill HD5012 / HD5012-3	1509003	-	25

Shank adapters

HI 12

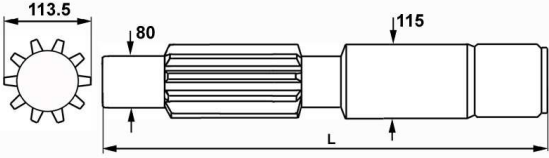
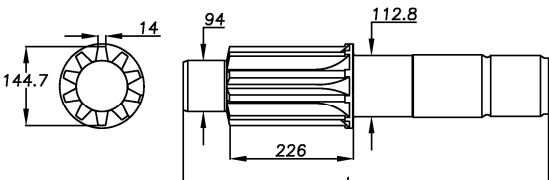
Adapter 112mm	Long. mm	Drifter	Ordering Number	Flushing Tube	Weight
	690	Klemm KD 1624	1511201	-	40.5
	669	Klemm KD 1828R	1511202	-	38

Button bits

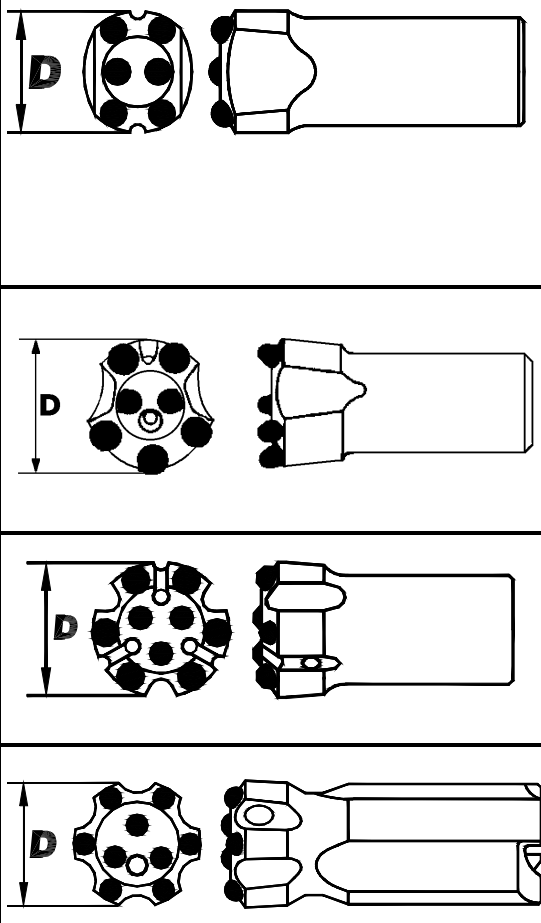
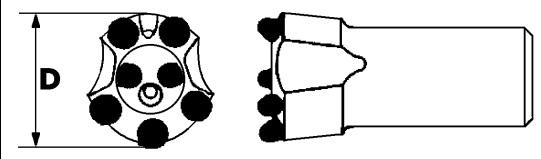
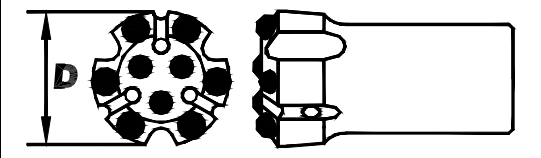
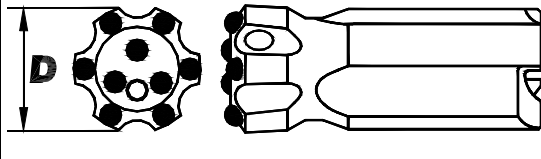
Bits	Diámetro		Thread	Buttons		Ordering Number	Weight	
	mm	Inch		Spherical Parabolic	Ballistic			
	38	1" 1/2	R-25	*	*	32503801	0.4	
	43	1" 11/16	R-25	*	*	32504301	0.55	
	45	1" 3/4	R-25	*	*	32504501	0.7	
	38	1" 1/2	R-28	*	*	32803801	0.45	
	41	1" 5/8	R-28	*	*	32804101	0.55	
	43	1" 11/16	R-28	*	*	32804301	0.65	
	43	1" 11/16	R-32	*	*	33204301	0.55	
	45	1" 3/4	R-32	*	*	33204501	0.55	
	48	1" 7/8	R-32	*	*	33204802	0.75	
	51	2"	R-32	*	*	33205105	0.95	
		38	1" 1/2	R-25	*	*	32503802	0.5
		51	2"	R-25	*	*	32505101	0.7
48		1" 1/2	R-32	*	*	33204801	0.8	
51		2"	R-32	*	*	33205106	1.0	
	51	2"	R-32	*	*	33205101	0.9	
	57	2" 1/4	R-32	*	*	33205704	1.1	
	57	2" 1/4	R-25	*	*	32505702	1.1	
	51	2"	R-32	*	*	33205107	1.1	
	57	2" 1/4	R-32	*	*	33205702	1.5	

Button bits

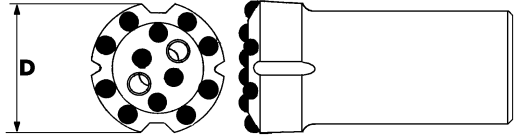
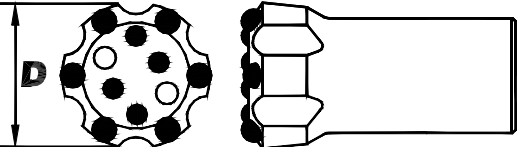
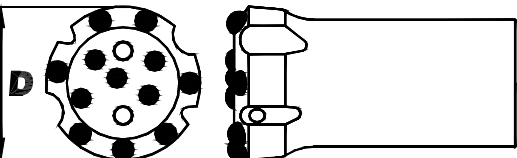
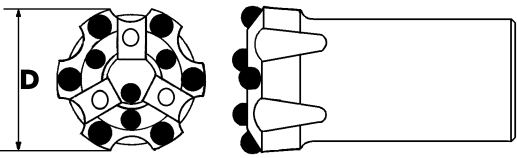
Bits	Diámetro		Thread	Buttons		Ordering Number	Weight
	mm	Inch		Spherical Parabolic	Ballistic		
		59 64	2" 1/3 2" 1/2			R-32 R-32	* *
	64	2" 1/2	R-38	*	*	33806401S	1.9
	59 64	2" 1/3 2" 1/2	T-38 T-38	* *	*	33805901 33806404	1.6 1.9
	70	2" 3/4	R-32	*	*	33207003	1.9
	70	2" 3/4	R-38	*	*	33807002S	2.1
	70	2" 3/4	T-38	*	*	33807002	2.1
	70	2" 3/4	T-45	*	*	34507005	2.2
	76	3"	R-32	*	*	33207601	2.1
	76	3"	R-38	*	*	33807601S	2.4
	76	3"	T-38	*	*	33807605	2.4
	76	3"	T-45	*	*	34507604	2.6
	70	2" 3/4	R-32	*	*	33207001	1.9
	70	2" 3/4	R-38	*	*	33807001S	2.1
	70	2" 3/4	T-38	*	*	33807001	2.1
	76	3"	T-38	*	*	33807601	2.4
	89	3" 1/2	T-38	*	*	33808904	3.3
	70	2" 3/4	T-45	*	*	34507001	2.3
	76	3"	T-45	*	*	34507603	2.8
	80	3" 1/7	T-45	*	*	34508001	2.1
	89	3" 1/2	T-45	*	*	34508905	3.7
	80	3" 1/7	T-51	*	*	35108001	2.4
	89	3" 1/2	T-51	*	*	35108904	2.6

Button bits

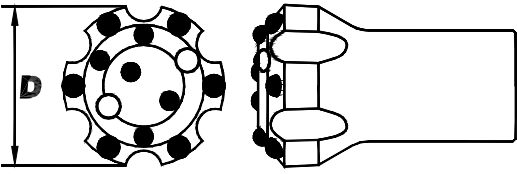
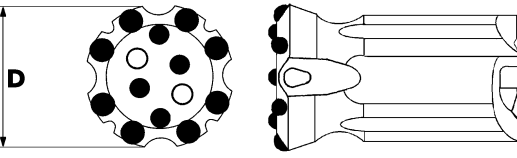
Bits	Diámetro		Thread	Buttons		Ordering Number	Weight
	mm	Inch		Spherical Parabolic	Ballistic		
		89	3" 1/2	T-38	*	*	33808909
89		3" 1/2	T-45	*	*	34508909	3.0
82 89		3" 2/7 3" 1/2	T-51 T-51	* *	* *	35108205 35108909	2.6 3.1
	64 70 76	2" 1/2 2" 3/4 3"	R-32 R-32 R-32	* * *	* * *	33206404 33207002 33207602	2.2 2.4 2.7
	70 76	2" 3/4 3"	R-38 R-38	* *	* *	33807004S3 3807603S	2.4 3.0
	64 70 76 89	2" 1/2 2" 3/4 3" 3" 1/2	T-38 T-38 T-38 T-38	* * * *	* * * *	33806405 33807003 33807607 33808906	2.4 2.7 3.0 3.8
	70 76 89	2" 3/4 3" 3" 1/2	T-45 T-45 T-45	* * *	* * *	34507003 34507606 34508901	2.9 3.2 3.8
	64 89	2" 1/2 3" 1/2	R-32 R-32	* *	* *	33206403 33208903	2.2 3.0
	64 70 76 89	2" 1/2 2" 3/4 3" 3" 1/2	R-38 R-38 R-38 R-38	* * * *	* * * *	33806402S 33807003S 33807602S 33808902S	2.6 2.9 3.1 3.9
	76 89	3" 3" 1/2	T-38 T-38	* *	* *	33807608 33808907	3.1 3.9
	76 89	3" 3" 1/2	T-45 T-45	* *	* *	34507607 34508907	3.4 4.2
	89	3" 1/2	T-51	*	*	35108905	4.4

Button bits

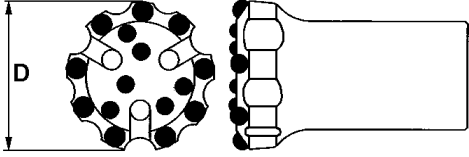
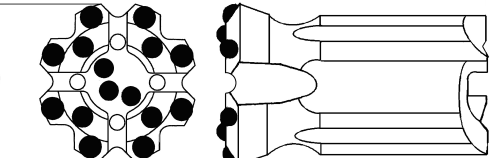
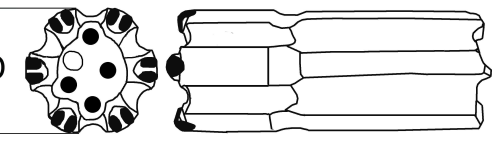
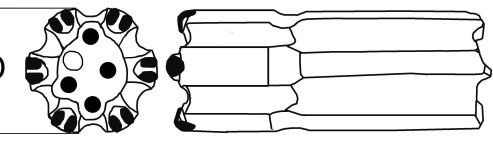
Bits	Diameter		Thread	Buttons		Ordering Number	Weight
	mm	Inch		Spherical Parabolic	Ballistic		
	89	3" 1/2	R-32	*		33208901	2.7
	102	4"	R-32	*		33210201	3.2
	89	3" 1/2	R-38	*		33808901S	2.9
	89	3" 1/2	T-38	*		33808905	2.9
	102	4"	T-38	*		33810201	3.4
	115	4" 1/2	T-38	*		33811502	3.8
	89	3" 1/2	T-45	*		34508906	2.9
	102	4"	T-45	*		34510202	3.8
	115	4" 1/2	T-45	*		34511502	4.2
	127	5"	T-45	*		34512701	4.5
	89	3" 1/2	T-51	*		35108903	2.9
	102	4"	T-51	*		35110202	4.1
	115	4" 1/2	T-51	*		35111502	4.3
	127	5"	T-51	*		35112701	4.5
	76	3"	T-38	*		33807608	3.1
	89	3" 1/2	T-38	*		33808908	4
	102	4"	T-38	*		33810203	6.0
	115	4" 1/2	T-38	*		3338115?	6.4
	127	5"	T-38	*		3338127?	6.9
	76	3"	T-45	*		34507607	3.4
	80	3" 1/7	T-45	*		34508002	3.7
	82	3" 2/7	T-45	*		34508204	4
	85	3" 1/3	T-45	*		34508505	4.1
	89	3" 1/2	T-45	*		34508908	4.2
	102	4"	T-45	*		34510203	6.0
	115	4" 1/2	T-45	*		34511503	6.4
	127	5"	T-45	*		34512702	6.9
80	3" 1/7	T-51	*		35108002	3.7	
82	3" 2/7	T-51	*		35108202	3.9	
89	3" 1/2	T-51	*		35108906	4.2	
102	4"	T-51	*		35110203	6.1	
115	4" 1/2	T-51	*		35111503	6.5	
127	5"	T-51	*		35112702	7.0	
	76	3"	T-45			34507620	3

Button bits

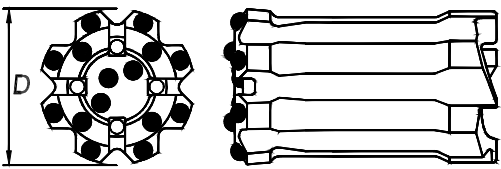
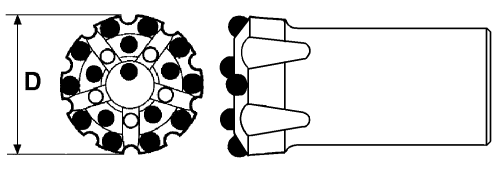
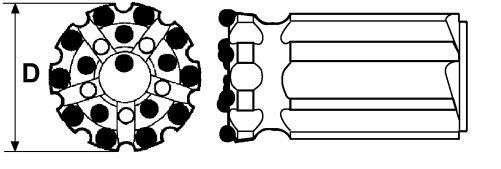
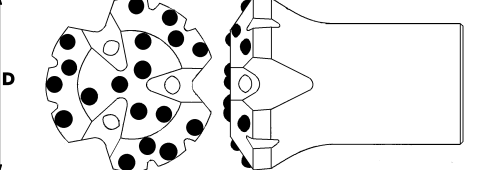
Bits	Diámetro		Thread	Buttons		Ordering Number	Weight
	mm	Inch		Spherical Parabolic	Ballistic		
		89 102 115	4" 4" ½	T-45 T-45 T-45	* * *		34508913 34510213 34511513
	89 102 115 127 140 152 162	3" ½ 4" 4" ½ 5" 5" ½ 6	T-51 T-51 T-51 T-51 T-51 T-51 T-51	* * * * * * *		35108911 35110213 35111508 35112704 35114002 35115204 35116201	5 6 7 8 11 13 15
	92 102 115 127 140 152	3" 5/8 4" 4" ½ 5" 5" ½ 6	KT-60 KT-60 KT-60 KT-60 KT-60 KT-60	* * * * * *		36009201 36010213 36011513 36012701 36014013 36015201	5.5 8 11 14 17 19
	102 115 127	4" 4" ½ 5"	ST-58 ST-58 ST-58	* * *		35810201 35811501 35812701	6.2 6.6 7.0
	102 115 127	4" 4" ½ 5"	ST-68 ST-68 ST-68	* * *		36810201 36811501 36812701	5.8 6.1 6.4
	115 127	4" ½ 5"	ST-68 ST-68	* *		36811502 36812702	6.7 7.1
	127	5"	T-2000	*		32012701	6.5

Coupling Sleeve

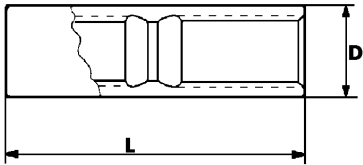
Coupling Sleeve	Length	Diameter	Thread	Ordering Number
	140	34	R-25	2252500
	150	41	R-28	2282800
	150	44	R-32	2323200
	170	55	R-38	238380S0S
	191	55	T-38	2383800
	209	64	T-45	2454500
	230	77	T-51	2515100
	305	85.5	T-2000	22000200000

Bit adapter coupling

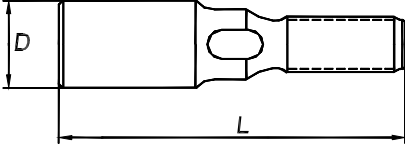
Bit adapter coupling	Length mm	Diameter mm	Thread Female	Thread Male	Ordering Number
	166	46	R-25	R-32	2253201
	183	54.5	R-32	R-25	2253210
	200	55	R-32	T-38	2323801
	191	55	T-38	R-32	2323810
	224	55	R-38	T-45	238450S1
	218	62	T-38	T-38	2383801
	267	55	T-38	T-45	2384501
	225	64	T-45	T-38	2384510
	218	68	T-45	T-45	2454501
	285	63	T-45	T-51	2455101
	285	71	T-51	T-45	2455110
	284	90	ST-58	ST-68	25868001

Reduction Coupling

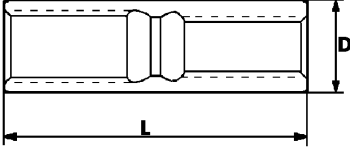
Reduction Coupling	Length mm	Diameter mm	Thread	Thread	Ordering Number
	149	46	R-25	R-32	2253202
	178	55	R-32	R-38	2323800S
	178	55	R-32	T-38	2323800
	180	55	R-28	T-38	2283800
	200	55	R-38	T-38	2383800S
	210	64	T-38	T-45	2384500
	224	77	T-45	T-51	2455100